

NOTE:

- MATERIAL:  
INSULATOR:THERMOPLASTIC  
CONTACTS:PHOSPHOR BRONZE
- CONTACTS FINISH:TIN OVER NICKEL
- PART NO.:  
**BHL118** - **xx** **R**  
SERIES NO. OF CONTACTS
- SUPPLIED IN EMBOSSED TAPE(3,000PCS./REEL)
- CURRENT RATING:0.5A MAX.
- VOLTAGE RATING:50V MAX.
- DIELECTRIC WITHSTANDING VOLTAGE:500Vrms.

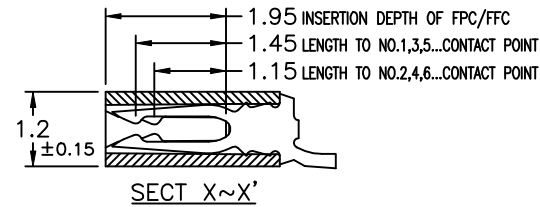
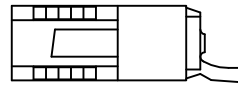
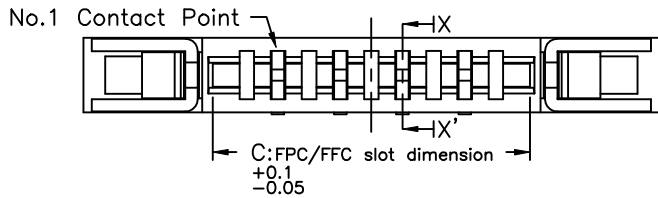
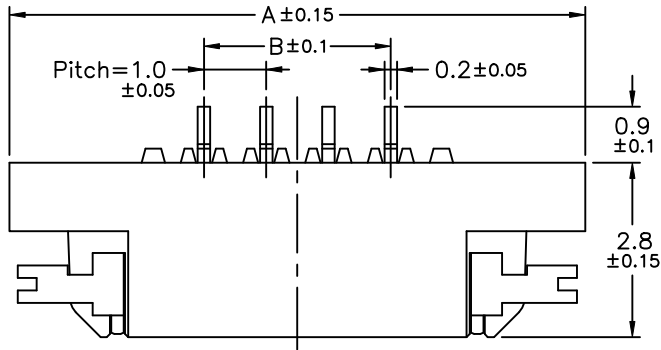

PCB Layout

Applicable FPC

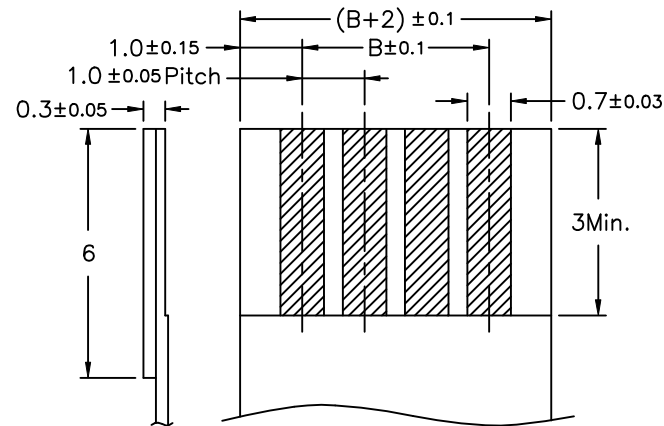
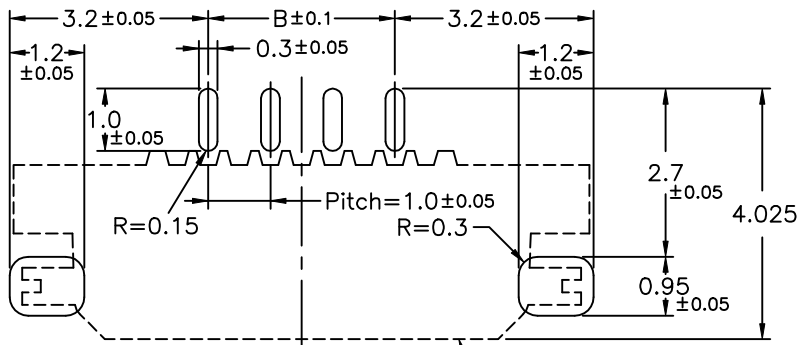

FPC/FFC INSERT DIRECTION  
Connector

No.of Contacts	Catalog Number	DIM. A	DIM. B	DIM. C
4	BHL118-4R	9.25	3	5.1
5	BHL118-5R	10.25	4	6.1
6	BHL118-6R	11.25	5	7.1
7	BHL118-7R	12.25	6	8.1
8	BHL118-8R	13.25	7	9.1
9	BHL118-9R	14.25	8	10.1
10	BHL118-10R	15.25	9	11.1
11	BHL118-11R	16.25	10	12.1
12	BHL118-12R	17.25	11	13.1
13	BHL118-13R	18.25	12	14.1
14	BHL118-14R	19.25	13	15.1
15	BHL118-15R	20.25	14	16.1
16	BHL118-16R	21.25	15	17.1
17	BHL118-17R	22.25	16	18.1
18	BHL118-18R	23.25	17	19.1
19	BHL118-19R	24.25	18	20.1
20	BHL118-20R	25.25	19	21.1
21	BHL118-21R	26.25	20	22.1
22	BHL118-22R	27.25	21	23.1
23	BHL118-23R	28.25	22	24.1
24	BHL118-24R	29.25	23	25.1

TOLERANCE UNLESS SPECIFIED		REV.	A	DR. BY	MATERIAL	See Note 1.
LINEAR	ANGLE	SHEET	1/2	CHK. BY	FINISH	See Note 2.
.X ±0.2	X	SCALE	8/1	APP. BY	DATE	9/4/2001
.XX ±0.15	.X	UNIT	mm		PART NO.	See Note 3.
.XXX ±0.05						

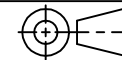

TITLE 1.0mm Pitch FPC/FFC Connector  
DWG NO. C1/BOOK/BOOK/BHL118/HP